



CDVI

31, av. du Gal Leclerc
93500 PANTIN FRANCE
Tel : 33 (0)1 48 91 01 02
Fax : 33 (0)1 48 91 21 21
www.cdvi.com

DG502U/A DG502U/P

2-DOOR CONTROLLER
500 USERS

NOTICE DE MONTAGE ET D'UTILISATION

Warning

Do not use a switching power supply because of the interference radiation that may disturb the reading of the badges

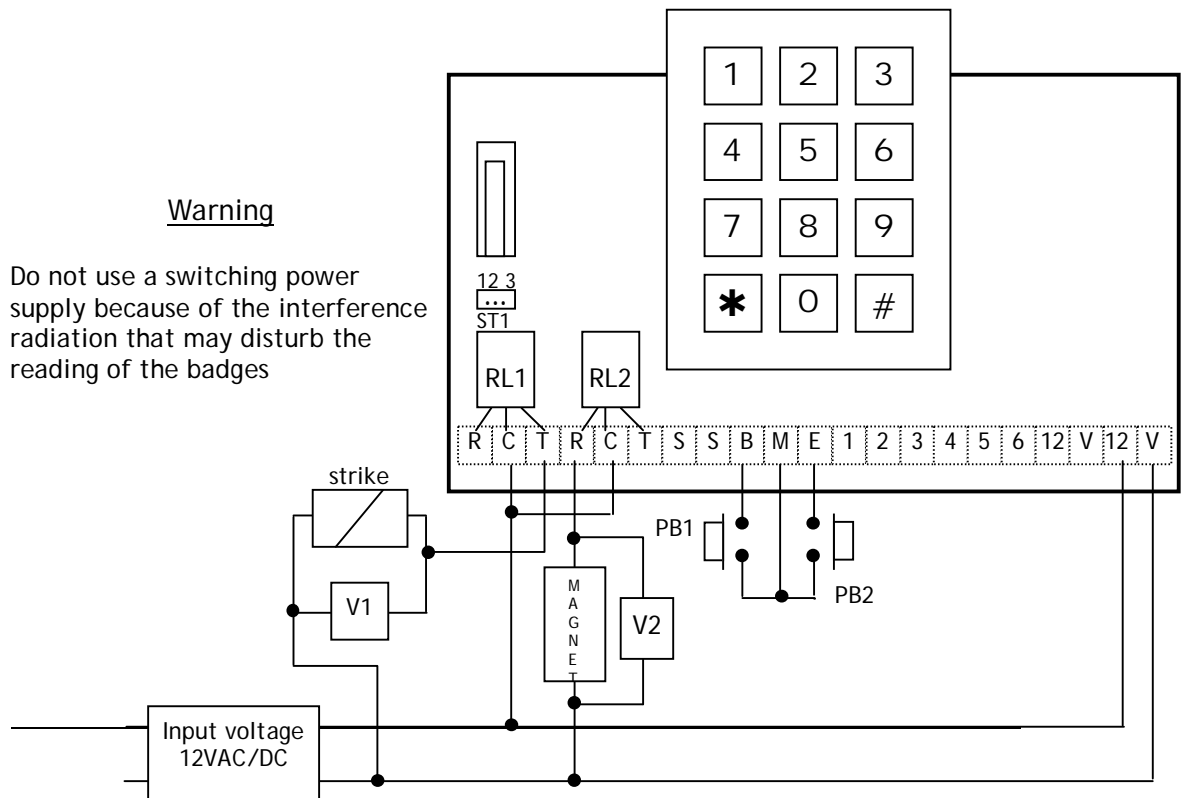

Terminal	Description
B	Request-to-Exit input 1
E	Request-to-Exit input 2
M	Common REX inputs
R	N/C Contact door
C	Common
T	N/O Contact door
V1, V2	Varistor
ST1	Jumper for reset
S, S	Tamper Switch output

This device comes with a varistor.
The varistor must be connected to the strike terminal (electromagnet...) operated by the device.
If this product works with many strikes, each of them should have a varistor.
The varistor controls the overload produced by the strike coil - self-effect.

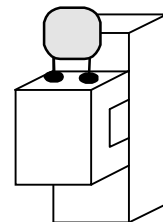

If you are using a « Shear Lock » electromagnetic lock, it is recommended to use a separate power supply than the one connected to the DG502U!

Technical specifications

Input voltage	12 VAC/DC
Outputs	2 form C relays N/O and N/C 3A @ 125V
Tamper switch	500 MA @ 50 VAC/DC
Cardholders	500 badges
Master code	5-digit master code
Inputs	2 REX inputs
Controller	12-digit keypad with built-in buzzer (Audible feedback)
Distance between the remote readers and the controller	60 cm minimum, 50 meters maximum (cable spec. 7 x 0.6 mm ²)

Default Factory Values

Master Code:	12345
Door release time:	1 second
Key-in Keypad:	10 seconds
Enrollment unit:	Built-in reader in controller

Power consumption

DG502 only:	160mA
DG502 with 1 remote reader:	240mA
DG502 with 2 remote readers:	320mA

Audible Sound Feedback

1 long beep	Validation of data in programming mode: master code, proximity badge or time delay. Or access code validated
2 short beeps	Accessing the programming mode or exit from the programming mode
4 short beeps	Badge not programmed (invalid badge) or incorrect master code or time delay entered

Visual LED Feedback

LED	Stand-by mode	Programming mode
Green	Door relay activated	User location free
Red	Alarm activated	User location
orange		Programming mode
orange flashing	Stand-by	Error data computing

Request-to-Exit Inputs

The two request-to-exit inputs PB1 and PB2 operate relay RL1 and RL2. The LED turns on green when the relay is activated by one of the two inputs.

Add a Badge

The badges can be programmed by group according to the access level selected in menu *4. You can program a series of badges then change the access level in menu *4 and program another series of badges.

1. Enter the master code twice (for the first use the master code default value is 12345). 2 beeps and the orange LED lights on to confirm that you have entered into the programming mode.
2. Enter *4 and select the access level 01 or 02 or 03 one beep is emitted.
3. Enter the user location (000 to 499). The LED lights off during 1 second and one beep is emitted.
4. If the LED turns green, present a badge in front of the enrolment reader (built-in proximity reader or auxiliary reader#1). The LED lights off during 1 second and one beep is emitted.
the LED lights on solid orange to confirm that the badge was programmed.
5. if the LED turns red (badge is already programmed in that user location), delete the badge or select another user location.
6. to program a badge with the same access level repeat from step 3
7. to program a badge with a different access level repeat from step 2

Press # to exit from the programming mode. 2 beeps confirm that you returned to reading mode.

4 beeps indicate a data computing error.

Delete or Replace a Badge

1. Enter the master code twice (for the first use the master code default value is 12345). 2 beeps and the orange LED lights on to confirm that you have entered into the programming mode.
2. Enter *4 and then select the access level 01 or 02 or 03 one beep is emitted.
3. Enter the user location from 000 to 499 to delete. The LED lights off during 1 second and 1 beep is emitted.
4. If the LED lights on in red it indicates that a badge is programmed at that user location.
5. Press * twice to delete the badge. The Led lights off during 1 second and 1 beep is emitted.
6. The LED lights on in green to confirm that the badge was deleted.
7. Press # to exit from programming.

OR

8. Present a new badge in front of the enrolment unit. The LED lights off during 1 second and 1 beep is emitted.
9. The LED lights on in orange to confirm that the new badge was programmed.
10. Press # to exit from programming. 2 beeps confirm that you returned to reading mode.

Reset of Master Code and Badges to Factory Default Values

1. Place ST1 jumper on, 2-3 position.
2. The LED flashes in green during 5 seconds. One beep confirms that the master code is restored to its factory default setting 12345. The LED starts then flashing in red.
3. Remove the jumper from 2-3 position to go back to stand-by mode.

OR

4. Keep the jumper on 2-3 position to delete all the badges from the controller.
5. The red LED flashes during 5 seconds then turns to solid red during the rest of the reset.
6. Once all the badges have been deleted, the LED lights off.
7. Remove the jumper from 2-3 position to go back to the stand-by mode.

Note: the time outputs and the enrolment reader are not set to their default settings.

Relay Outputs

Badge 1 - Access Level 01

Controller built-in reader activates relay 1
Remote reader 1 activates relay 1

Badge 2 - Access Level 02
relays

Controller built-in reader activates no
Remote reader 2 activates relay 2

Badge 3 - Access Level 03

Controller built-in reader activates relay 1
Remote reader 1 activates relay 1
Remote reader 2 activates relay 2

Reset to Factory Default Values

Cut the power on the DG502 unit

Place the jumper on ST1, 2-3 position

Power on the DG502, the LED is still off

Remove the jumper from ST1, 2-3 position, the LED flashes orange

Wiring of the Remote Readers

Follow the schematic on page 1 to connect remote reader 1 to the controller. Connect terminals 2, 3, 4, 5, 12 and V from the controller directly to the terminals on the remote reader 1. Terminal 6 on the controller is connected to terminal 1 of remote reader 1.

For remote reader 2, connect in parallel terminals 2, 3, 4, 5, 12 and V from the controller unit. Terminal 1 on the controller is connected to terminal 1 of remote reader 2.

To power the remote readers use a different power supply or use the 12V output from the controller (At the right hand completely it is the inputs 12V of the controller. The 12V at the left of the other 12V is the output).

Template

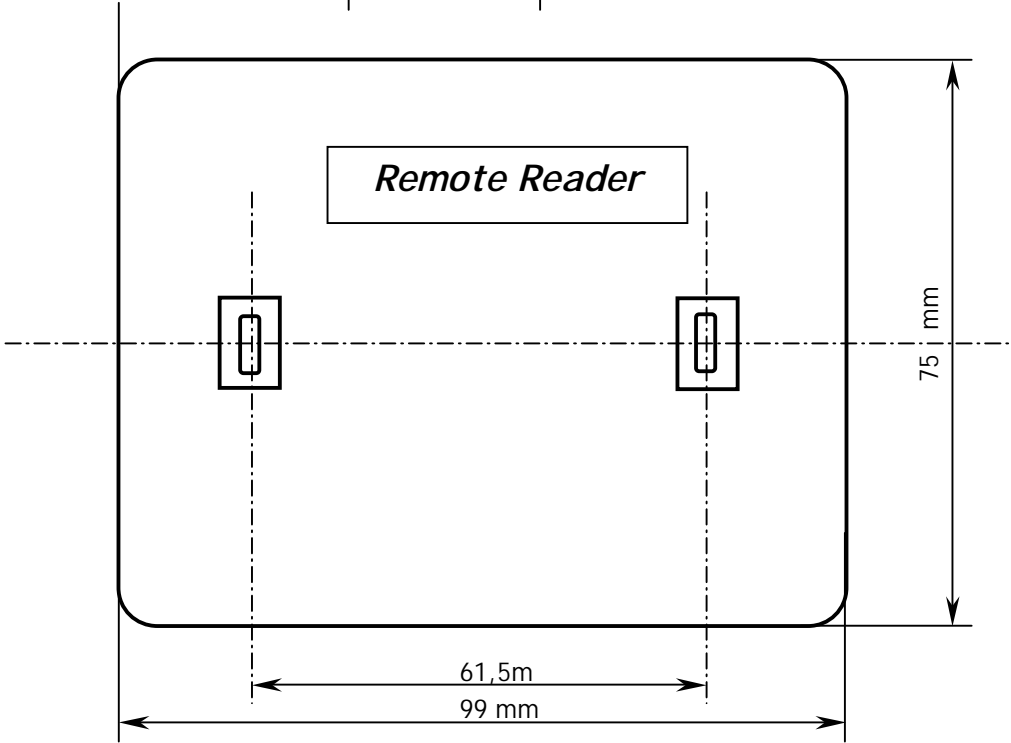
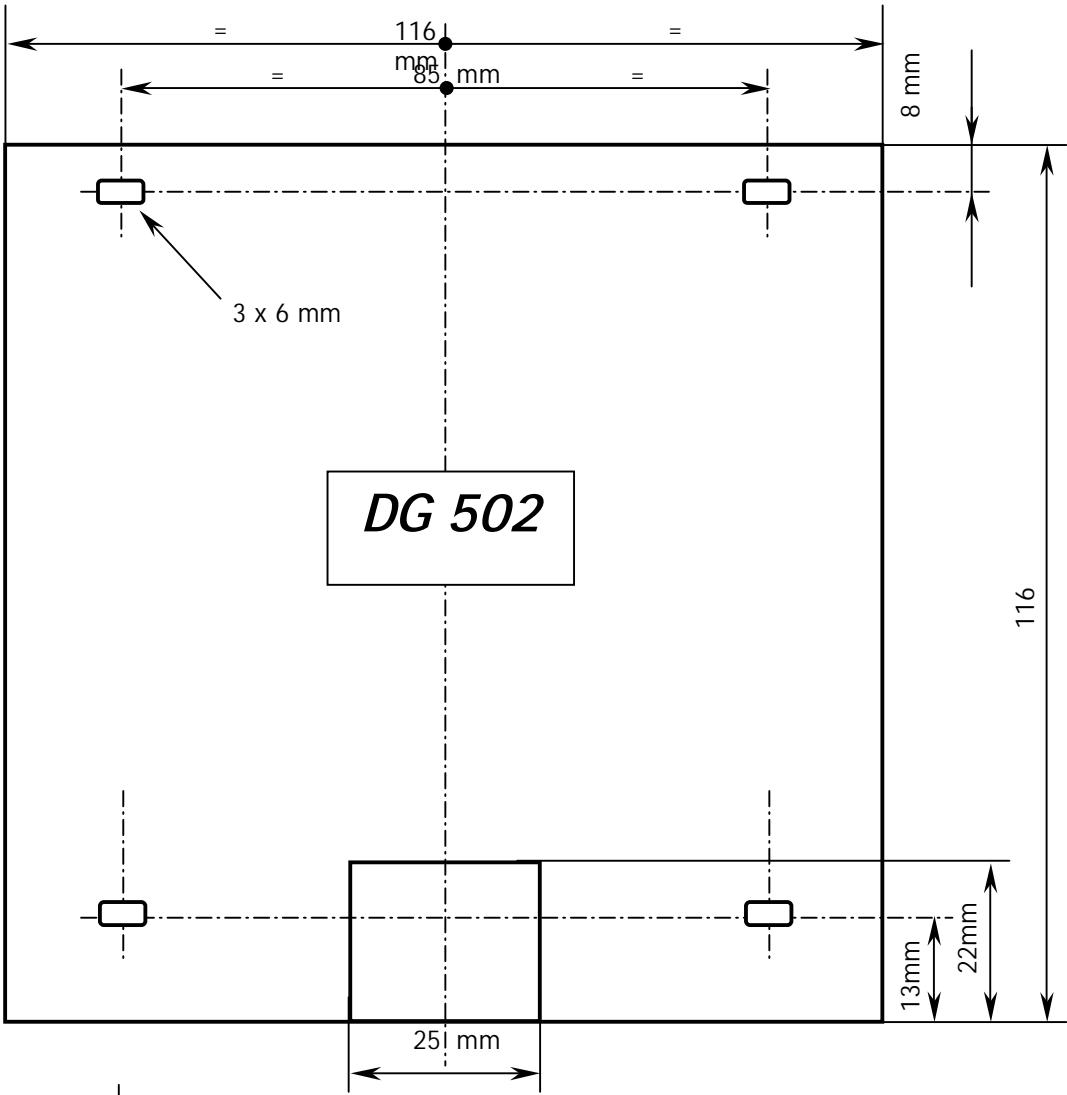

Wiring Diagram between the DG502 and Remote Reader 1

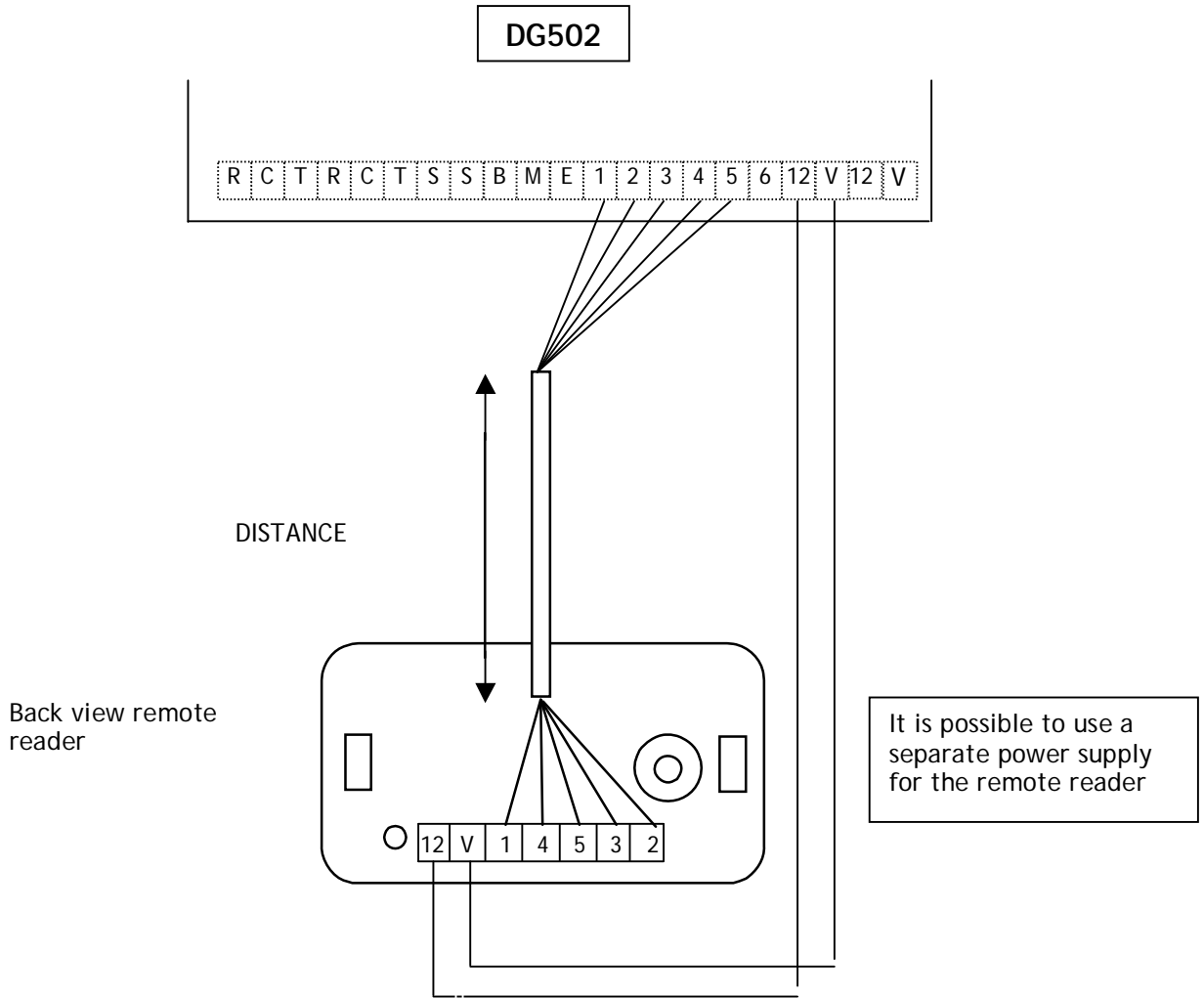

WIRING DG502–Remote reader 2		
DG502 controller		Reader 2
12	Input voltage	12
V	Input voltage	V
1	Data	1
2	Buzzer	2
3	Green LED	3
4	Common	4
5	Red LED	5

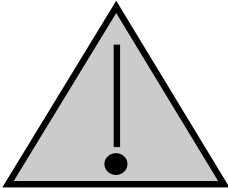

It is recommended to keep a distance of 60 CM minimum between the DG502U Controller and a remote reader, between 2 remote readers or between 2 DG502U controllers.

Wiring Diagram between the DG502 and Remote Reader 2

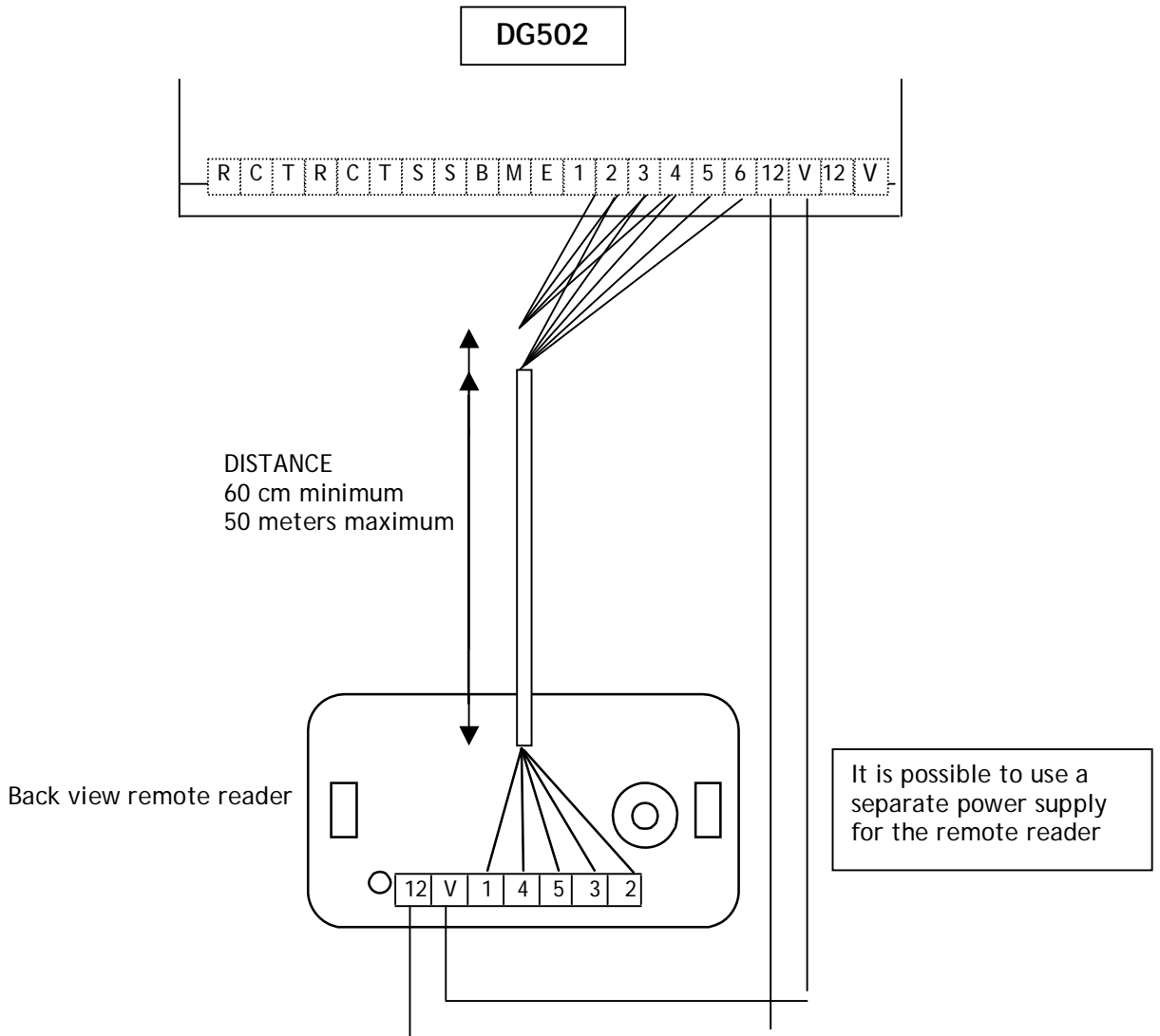

DG502–remote reader 1		
DG502 controller		Remote reader 1
12	Input voltage	12
V	Input voltage	V
6	Data	1
2	Buzzer	2
3	Green LED	3
4	Common	4
5	Red LED	5

