



LAC 100

STAND-ALONE CONTACT BADGE READER AND KEYPAD CODE 100 BADGES AND/OR 100 USER CODES

Wiring diagram

R	Normally close	P1	Push button relay 1
C	Common	P2	Push button relay 2
T	Normally open	M	common P1 and P2
V1, V2	varistors		

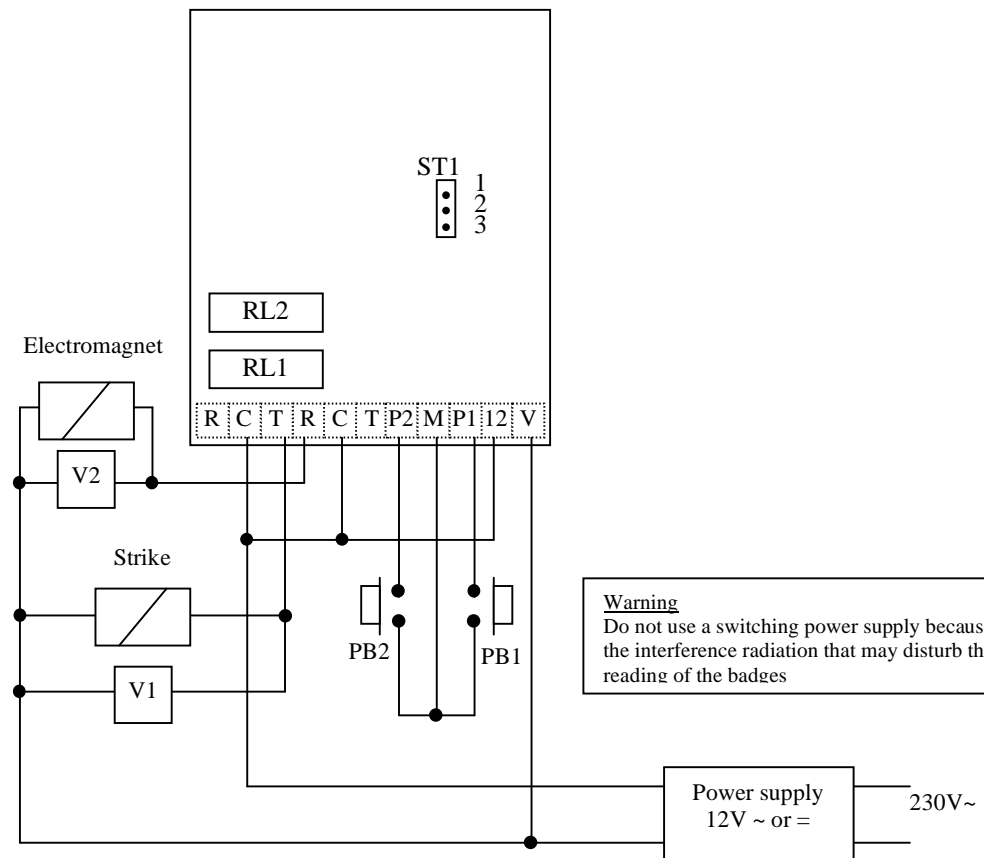

Warning

Do not use a switching power supply because of the interference radiation that may disturb the reading of the badges

This device comes with a varistor.

The varistor must be connected to the strike terminal (electromagnet...) operated by the device.

If this keypad code is connected to more than one strike, each strike should have a varistor.

The varistor controls the overload produced by the strike coil – self-effect.

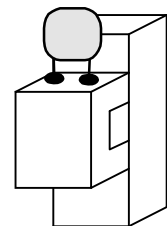

If you are using a « Shear Lock » electromagnetic lock, it is recommended to use a separate power supply than the one connected to the LAC 100.

Technical specifications

Input voltage	12 V ~ or =
Outputs	2 relays 1 contact N.O and N.C 8A/250V~
User codes	100 user codes programmable in 2 groups (2 x 50 user codes)
Master codes	1 programmable master code for the keypad and 1 programmable master code for the contact badge reader
Code length	5-digit user code and master code
Inputs	2 request-to-exit
Front plate	12-digit keypad with contact badge reader
Operating modes	2 operating modes : - code or badge, - code & badge

Warning Do not use a switching power supply because of the interference radiation that may disturb the reading of the badges

Default values

Master code: 12345 for the keypad, 67890 for the contact badge reader
 Relay time delay: 1 second in momentary output
 Keypad key-in delay: 10 seconds
 Programming delay: 120 seconds (2 minutes)

Group codes

GROUP	READER	RANK	RELAY	KEY FUNCTION
1	Keypad	00 to 49	RL1	*1
	Contact badge reader	00 to 49		
2	Keypad	50 to 99	RL2	*2
	Contact badge reader	50 to 99		

Code definition

For the master code and the user codes use a 5-digit code.
 The keys 0 to 9, * and # can be used to program a user code.
 The master code can not be used as a user code.
 Code 00000 is reserved to cancel an existing code and then can not be used as a user code.



Request-to-exit

The 2 request-to-exit buttons can operate relay 1 RL1 and relay 2 RL2 independently (the time delays and modes are programmable).



Operating the 2 relays simultaneously

A user code or a contact badge can be programmed in the 2 groups in order to activate the 2 relays at the same time (the time delays and modes are programmable).

Setting a Master code for the keypad

1. Enter twice the keypad master code (for the first use the factory's master code is 12345).
The message  confirms that you are in programming mode.
2. Enter *3, message  allows you to change the code. Enter the new 5-digit master code.
3. The display lights off during 1 second indicating the validation of the code.
4. Press on # to exit from the programming mode. The display lights off.



Setting a Master code for the contact badge reader

1. Enter twice the contact badge master code (for the first use the factory's master code is 67890).
The message  confirms that you are in programming mode.
2. Enter *4, message  allows you to change the code. Enter the new 5-digit master code.
3. The display lights off during 1 second indicating the validation of the code.
4. Press on # to exit from the programming mode. The display lights off..

Setting Time delays

Enter twice the keypad master code (for the first use the factory's master code is 12345).

The message  confirms that you are in programming mode.



Time delays	Keypad Function	Display	Values	Validation
Keypad key-in delay	*0		from 10 up to 99 seconds	The display lights off during 1 second
Time delay RL1	*1		00 for latched output, 01 for 1 second up to 99 for 99 seconds	The display lights off during 1 second
Time delay RL2	*2		00 for latched output, 01 for 1 second up to 99 for 99 seconds	The display lights off during 1 second

Press # to exit from the programming mode. The display lights off.

Configurations

Enter twice the keypad master code (for the first use the factory's master code is 12345).

The message  confirms that you are in programming mode.

Configuration	Key Function	Display	Values	Validation
code or badge	*5		00	The display lights off during 1 second
code & badge	*5		01	The display lights off during 1 second

Press on # to exit from the programming mode. The display lights off.

Setting User codes

1. Enter twice the master code (for the first use the factory's master code is 12345).

The message  confirms that you are in programming mode.

2. Enter the rank number to program (00 up to 49 for relay RL1, 50 up to 99 for relay RL2). If the rank is not programmed, the display shows the number without the dot, for example 42 

If the rank is not free the display indicates. 

You either have to cancel this user code, or to choose another rank number.

3. Enter the 5-digit code.
4. The display lights off during 1 second indicating the validation of the code.
5. Press on # to exit from the programming mode. The display lights off.

The master code can not be used as a user code.

Code 00000 is used for the cancellation of a user code and so can not be used a user code.

Setting contact badges

Enter twice the contact badge reader master code (for the first use the factory's master code is 67890).

The message  confirms that you are in programming mode.

1. The display shows the first rank number available (free).
Enter the rank number that you would to like to program (00 to 49 for relay RL1, 50 to 99 for relay RL2).

If the rank number is not free, the display indicates a number without a dot example 42 

If the rank is already taken the display indicates. 

Either cancel the programmed rank, or choose another rank number.

2. Present the badge in front of the reader.
3. The display lights off during 1 second indicating the validation of the badge.
4. The system displays the next rank number available.
5. Press on # to exit from the programming mode.

After rank number 99 the system displays rank number 00.

Canceling or replacing a badge

1. Enter twice the contact badge reader master code (for the first use the factory's master code is 67890).

The message  confirms that you are in programming mode.

2. Enter the rank number. If the rank is occupied the display indicates, example 42.



3. To cancel this badge number, press twice on *. The display shows



4. Press on # to exit from the programming mode. The display lights off.

Or

5. Present the new badge to replace the cancelled one.
6. The display lights off during 1 second indicating the validation of the badge.
7. Press on # to exit from the programming mode. The display lights off.

Reset the Master codes and the badges

1. Put the jumper ST1 on position 2-3.

2. This message  is displayed during 5 seconds, then the display lights off during 1 second. The master codes 12345 for the keypad and 67890 for the badges replace the old ones that were programmed.

3. The display indicates 



4. Remove the jumper ST1 from position 2-3 if you reset only the master codes, the display lights off and the system goes back to a normal mode.

5. **OR**

6. Leave the jumper ST1 on position 2-3 to cancel all the programmed badges in the 2 groups.
7. The display indicates  during the cancellation of the badges, then the display lights off

8. Remove the jumper ST1 from position 2-3 and the system goes back to the normal mode

Configuration

Type of code	Result	Modes	Display
User code Or badge	The first digit activates the keypad key-in time delay At the end of the keypad time delay the system cancels the data entry	Latched output	Display the rank number until the user code is entered again or the badge is presented again
		Momentary output, 1 to 99 seconds	Display lights off
User code and badge	Recognition of the code activates the keypad key-in time delay, at the end of the delay the system cancels the data entry	Waiting to present the badge of the same group	 Display on stand-by, then lights off during opening.
		Do not need to present the badge of the same group	 Display on stand-by then lights off

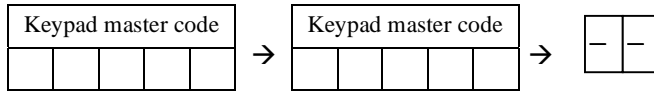

Group 1 (rank from 00 up to 49) activates RL1

00						01						02						03					
04						05						06						07					
08						09						10						11					
12						13						14						15					
16						17						18						19					
20						21						22						23					
24						25						26						27					
28						29						30						31					
32						33						34						35					
36						37						38						39					
40						41						42						43					
44						45						46						47					
48						49																	

Group 2 (rank from 50 up to 99) activates RL2

50						51						52						53					
54						55						56						57					
58						59						60						61					
62						63						64						65					
66						67						68						69					
70						71						72						73					
74						75						76						77					
78						79						80						81					
82						83						84						85					
86						87						88						89					
90						91						92						93					
94						95						96						97					
98						99																	

Key-in time delay	relay 1 time delay	relay 2 time delay
*0 <input type="text"/>	*1 <input type="text"/>	*2 <input type="text"/>

To exit from programming mode press on #.

Supervisor :	date
Building :	
N° :	Street :
City :	
Other information :	