

SDA

DOUBLE ACTION SOLENOID LOCK

GENERAL

The SDAXX and SDAXXI double action locks offer a low cost solution for a new installation and for replacement of an existing lock and a lot more advantages compare to simple mechanical lock, electric strike and other locks.

The SDAXX lock can be used on a PULL, PUSH or swinging door, as well as in Din right or Din left.

There are many applications possible for the lock since the SDAXX can be fitted on external doors and internal doors (offices, ...).

The lock can be operated by keypad, a stand alone access control system or an online access control system.

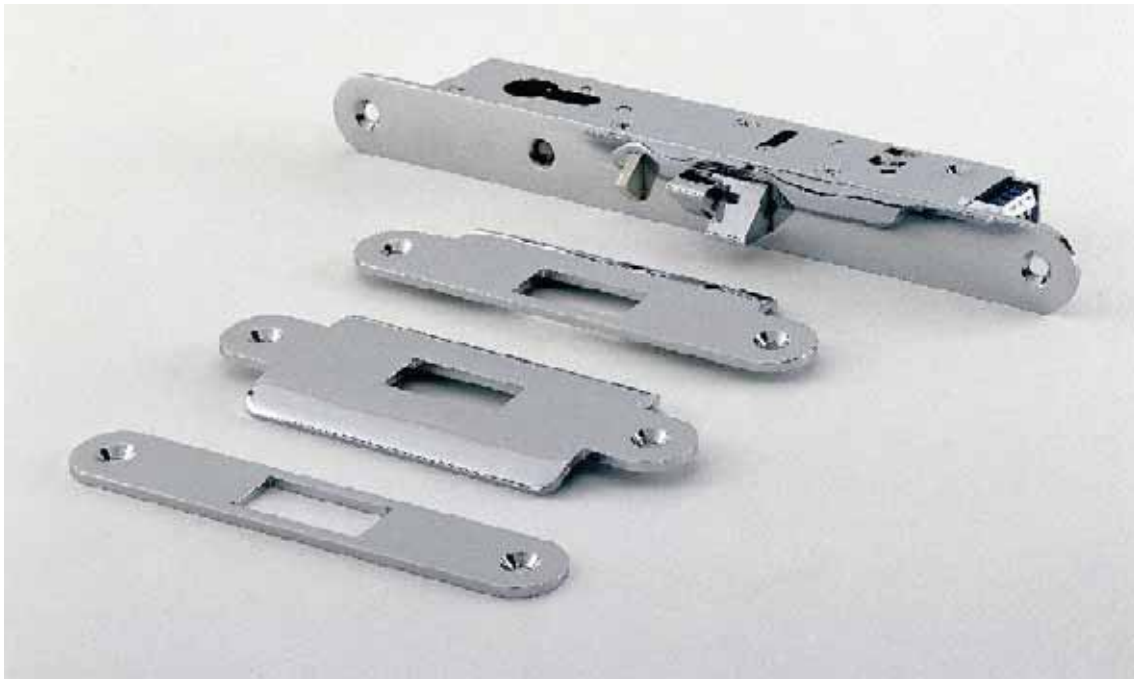

The lock includes:

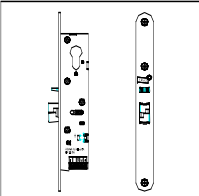
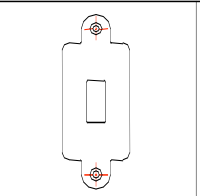
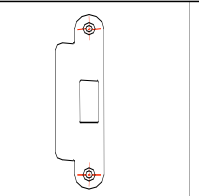
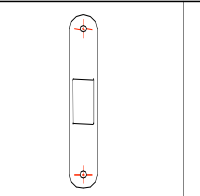
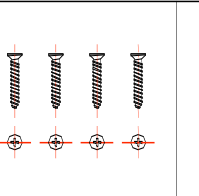
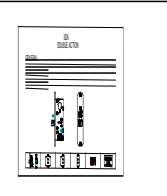
					
SDA lock x1	Strike plate x1	Strike plate x1	Filler plate x1	Screws x4	Manual x1

WIRING DIAGRAM

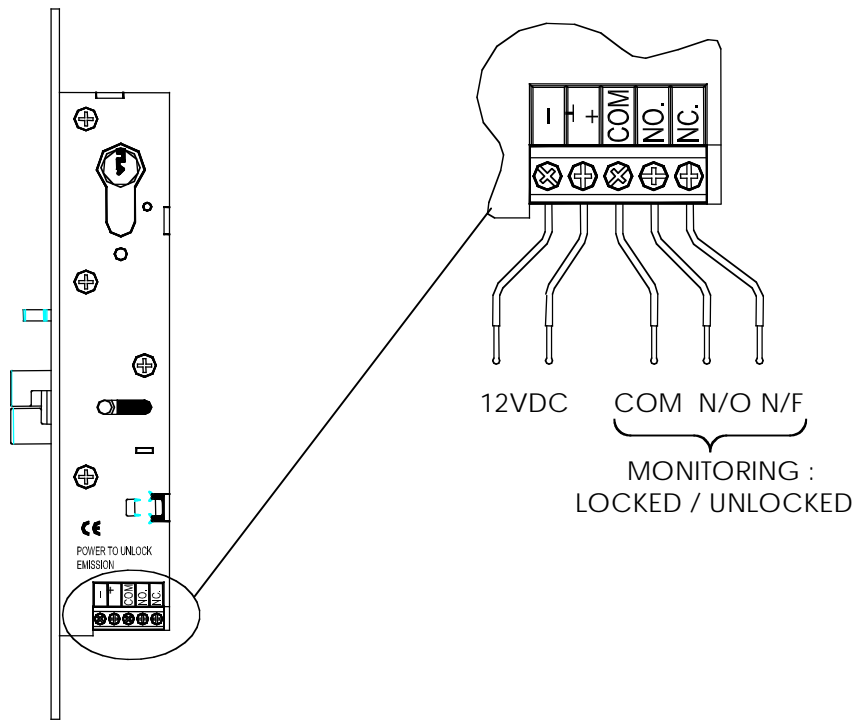

MODEL CHART TABLE

REFERENCE	DESCRIPTION
SDA 25	Double action lock 12 VDC, backset 25, fail secure
SDA 30	Double action lock 12 VDC, backset 30, fail secure
SDA 35	Double action lock 12 VDC, backset 35, fail secure
SDA 25I	Double action lock 12 VDC, backset 25, fail safe
SDA 30I	Double action lock 12 VDC, backset 30, fail safe
SDA 35I	Double action lock 12 VDC, backset 35, fail safe

